

SAMSUNG® ML-3750 (MLT-D305L) TONER CARTRIDGE REMANUFACTURING INSTRUCTIONS



SAMSUNG® MLT-D305L TONER CARTRIDGE

REMANUFACTURING THE SAMSUNG ML-3750 TONER CARTRIDGE

By Javier Gonzalez and the Technical Staff at UniNet

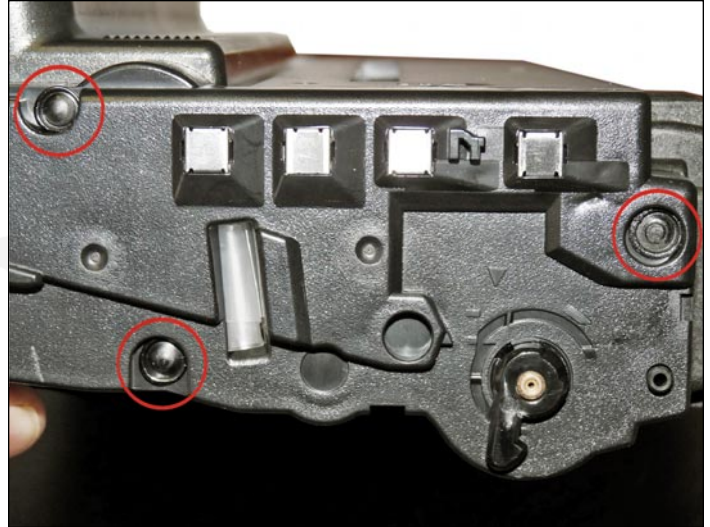
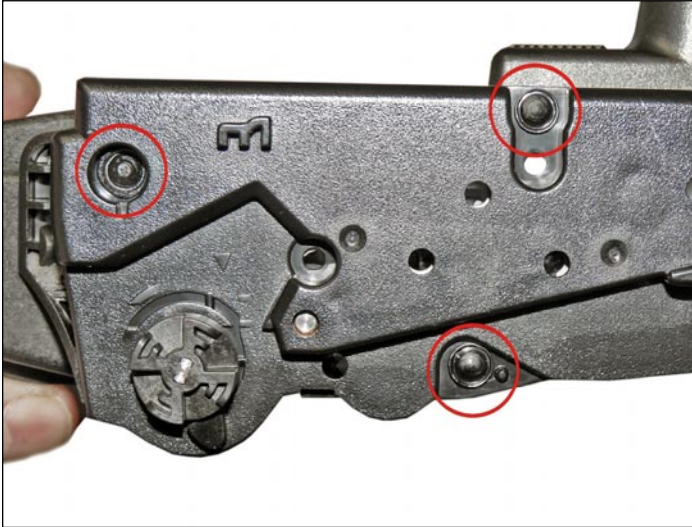

The Samsung ML-3750 series of printers are based on a 37 ppm engine, with a maximum resolution of 1200 x 1200 dpi. The first page out is stated to be under 6.5 seconds. Depending on the model number, other options and specifications are available.

The MLT-D305L cartridges do not have a drum cover, but come new with a piece of heavy paper with a thin sheet of foam on the inside taped around the cartridge.

These cartridges (pictured here), while looking similar to other Samsung-type cartridges, have taken a dramatic change in that there are no screws on the outside of the cartridge at all. There are plastic rivets that need to be cut off, holes drilled, and screws installed to hold them back on. It is not a hard process, and is covered completely in the instructions.

The Samsung high yield cartridge (MLT-D305L) is rated for 15,000 pages.

As with pretty much all cartridges these days, the cartridge has a chip that has to be replaced each cycle. The OEM chips are regional, so be sure to get the proper chip for your region. Most of the machines in this series, when new, ship with a 7,000-page starter cartridge.

LASER PRINTERS THAT USE THESE CARTRIDGES

ML-3750N

ML-3750ND

Cartridge troubleshooting will be listed at the end of these instructions.

REQUIRED TOOLS

1. Toner approved vacuum
2. A small common screwdriver
3. A Phillips head screwdriver
4. Needle nose pliers

REQUIRED SUPPLIES

1. Toner for use in Samsung ML-3750
2. New replacement chip for use in Samsung ML-3750 (check for the proper region)
3. New OPC drum (optional)
4. New developer roller (optional)
5. New PCR (optional)
6. New wiper blade (optional)
7. New doctor blade (optional)
8. Conductive grease
9. 99% isopropyl alcohol
10. Drum lubricating powder
11. Small tube of silicone caulk



1. On the contact side of the cartridge, slice off the heads of the three plastic rivets with a chisel blade knife. If your knife is too wide, you may find it necessary to drill out the upper recessed rivets on both sides. Leave the end cap on for now.

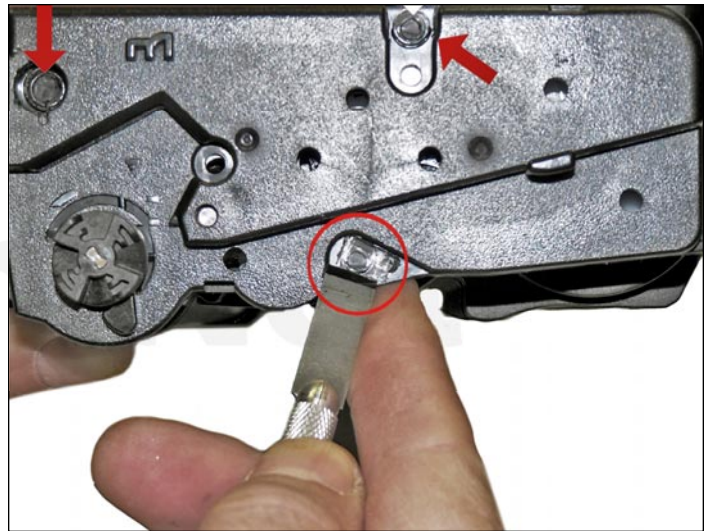

2. On the opposite side end cap, take the chisel blade knife and slice off the heads of the three plastic rivets. See previous step for recessed rivets. Leave the end cap on for now.

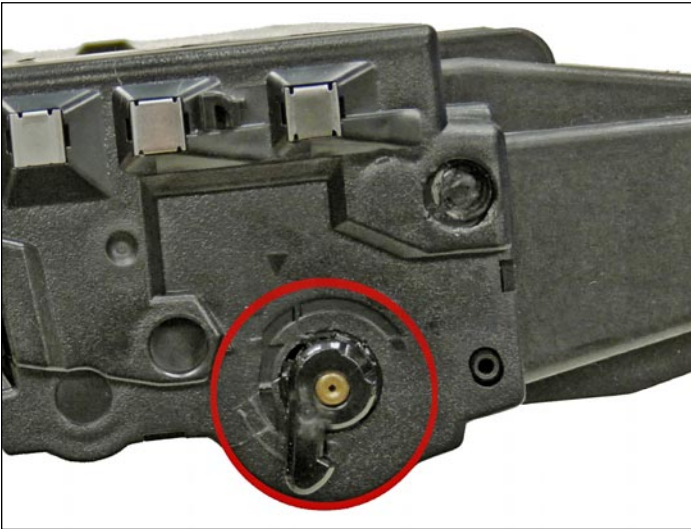

3. The drum axle arms on both sides of the cartridge stay with the end cap. There is no need to remove them.



4. Remove the drum drive-gear.



5. While still on the same side, locate the two tabs.

Press in on each tab, and remove the end cap.

The drum axle arm will come off with the end cap.

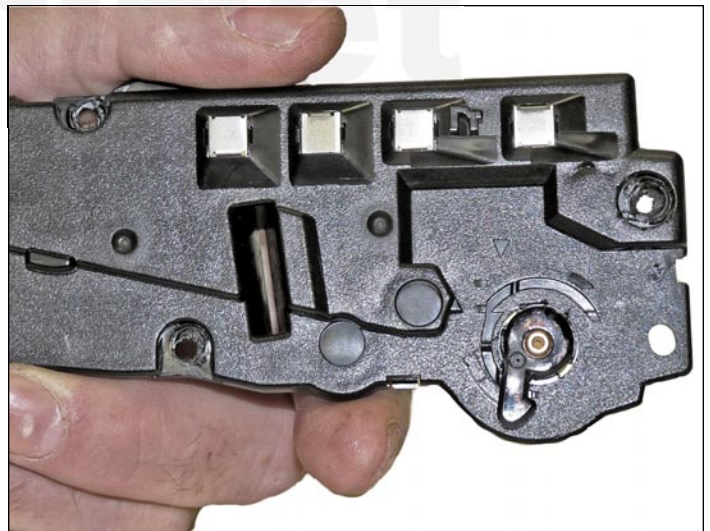

6. On the right side end cap, press in on the three tabs and remove the end cap.

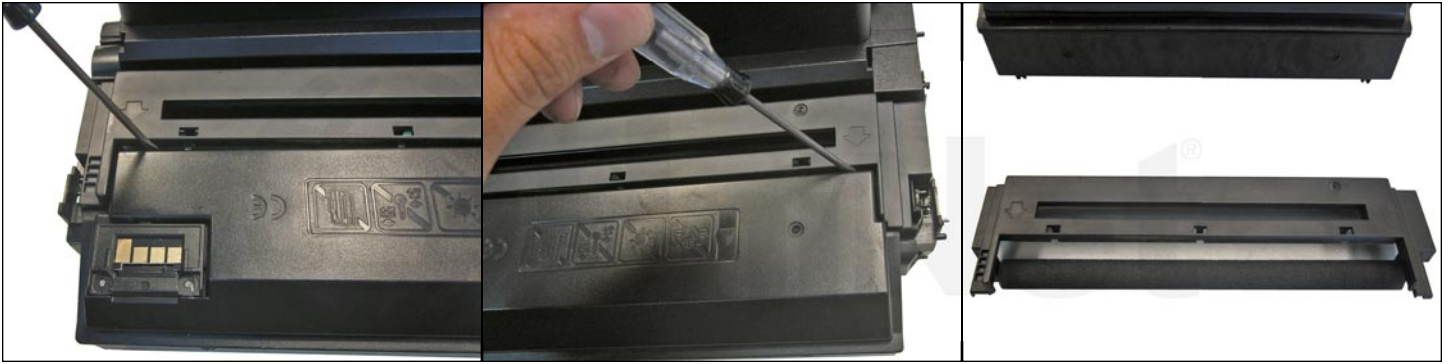

7. Separate the two halves slightly, snapping the the middle top cover off, using a small flat head screwdriver.

Remove the cover as shown.

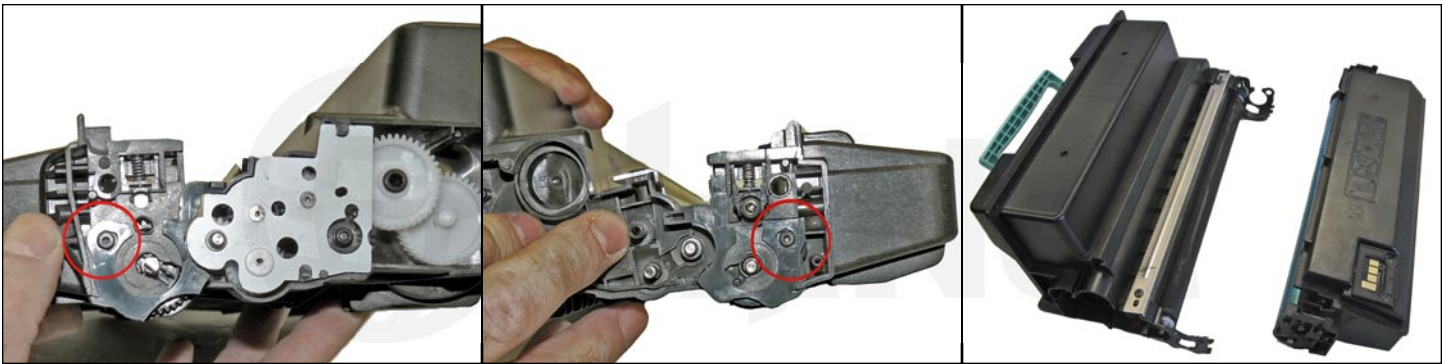

8. Gently pry up on the tabs on both sides of the cartridge and remove the waste hopper.

Be careful to hold the drum so it does not become damaged.

Remove the drum/waste assembly.



9. Remove the drum.



10. Remove the PCR from the assembly. Clean the PCR with your normal PCR cleaner.

WARNING: Do not clean the OEM PCR with alcohol, as this will remove the conductive coating from the roller. If the PCR is an aftermarket, follow the cleaning methods recommended by the manufacturer. If the PCR is an OEM, we recommend it be cleaned with your standard PCR cleaner.

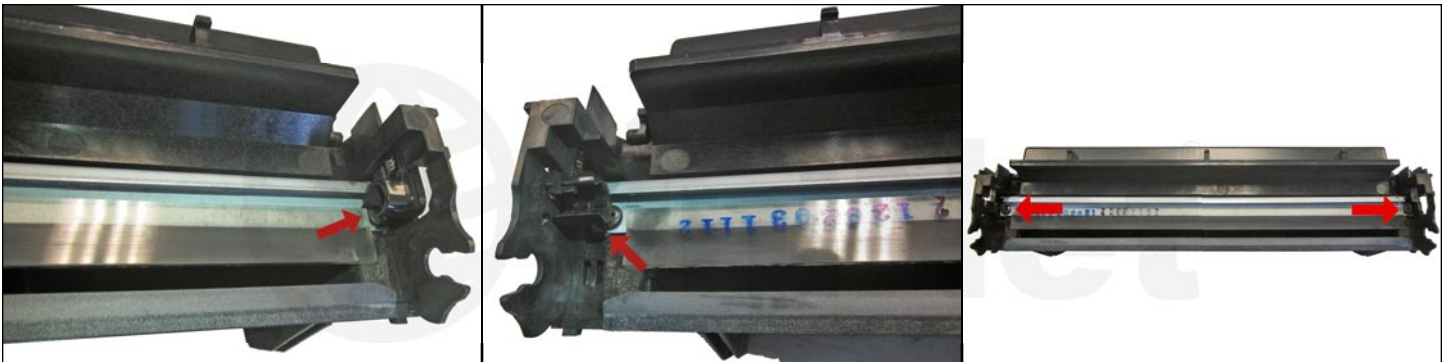

11. Remove the PCR holders.

They are located above the wiper blade screws, and will need to be removed to gain access to the screws.

12. Remove the two screws from the wiper blade, and remove the blade.



13. Clean out all the waste toner from the hopper.

Make sure the seals are clean.



14. Install the new wiper blade and two screws.

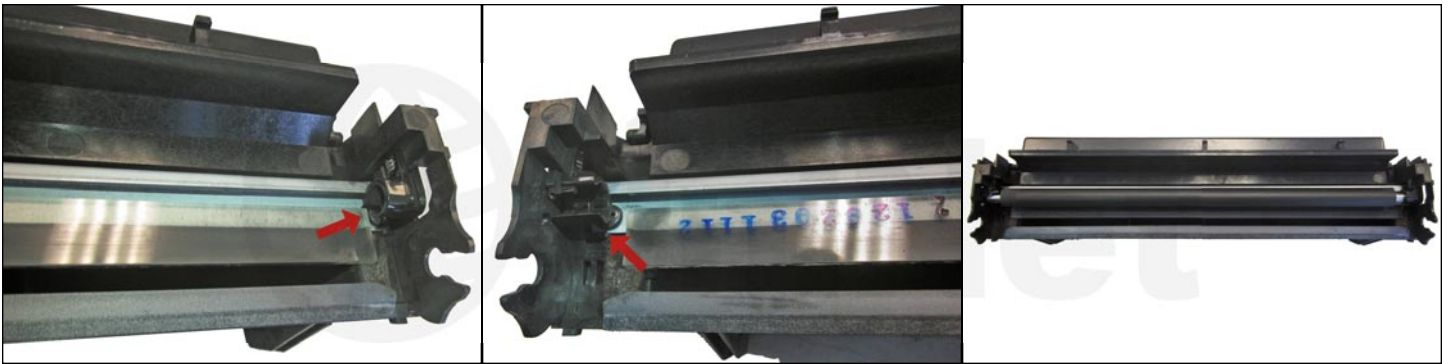

15. Install the PCR holders.

Place a small amount of conductive grease in the holders, and install the PCR.

The long shaft side goes to the gear side (non-chip side).



16. Install the drum into the waste hopper, with the large gear of the drum to the gear side (non-chip side).

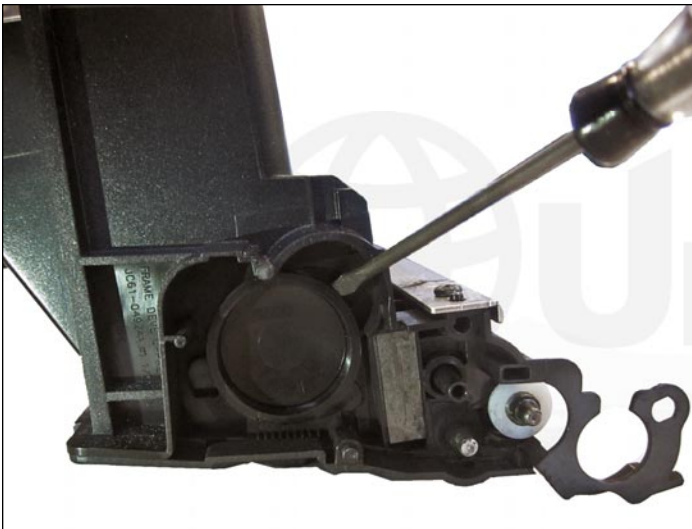

17. On the supply hopper, carefully pry out the fill plug and dump out any remaining toner. The fill plug can be difficult to remove as it is recessed. Take a small common screwdriver and work it around the edge, lifting slightly until it comes loose.



18. Pry off the gear plate, and remove the gears.



19. Remove the developer roller bushings from both sides.



20. Remove the developer roller.

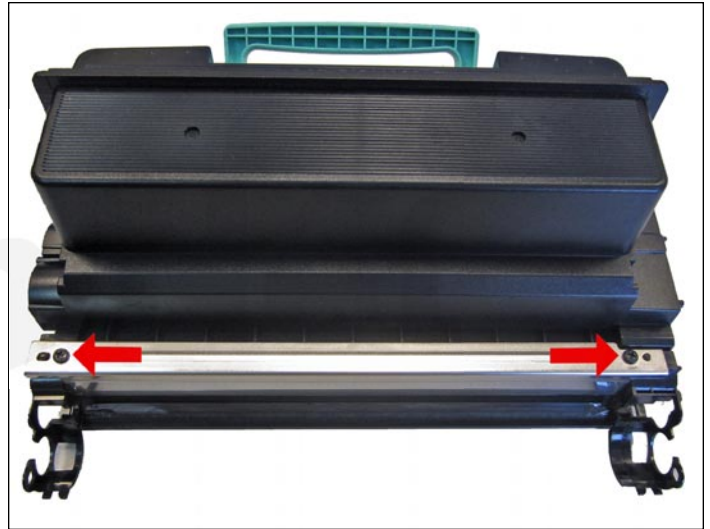

21. Remove the two screws from the doctor blade, and remove the blade. Clean out all the remaining toner from the hopper.

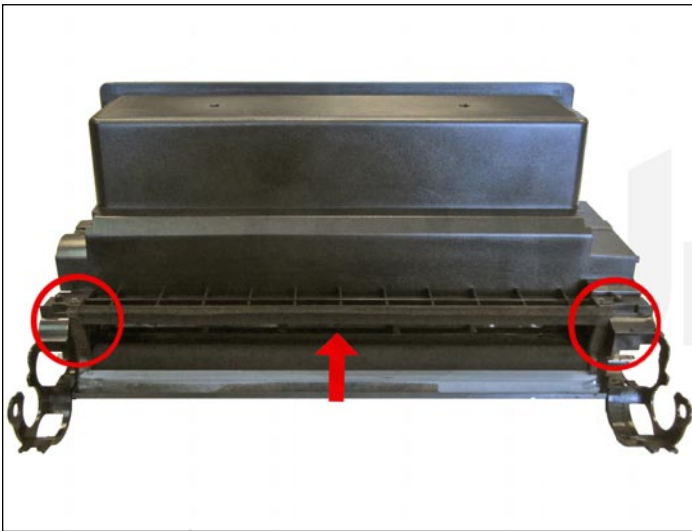

22. Make sure the doctor blade sealing foam and the developer roller seals are clean and intact.



23. Clean the doctor blade edge so there is no evidence of build up along the edge. If any buildup exists, the cartridge will streak. No chemicals should be used. We have found using a clean, wooden ice cream-type stick works great for scraping the blade clean without damaging it.



24. Install the seal when available through the developer roller opening.

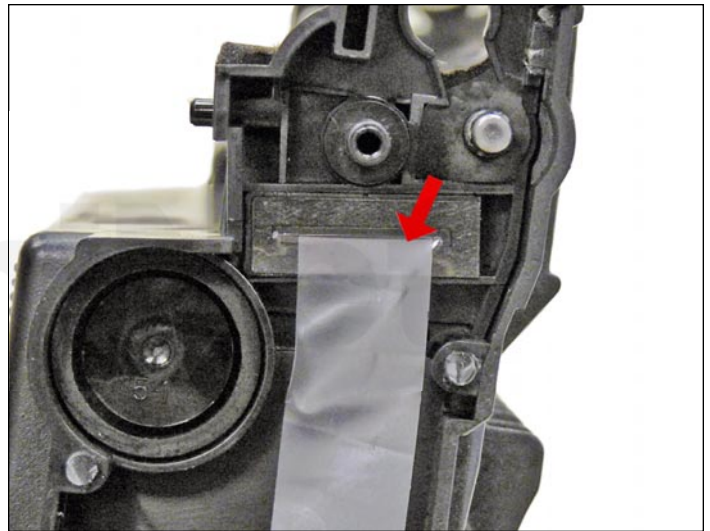

25. Pull the tail of the seal through the seal port.

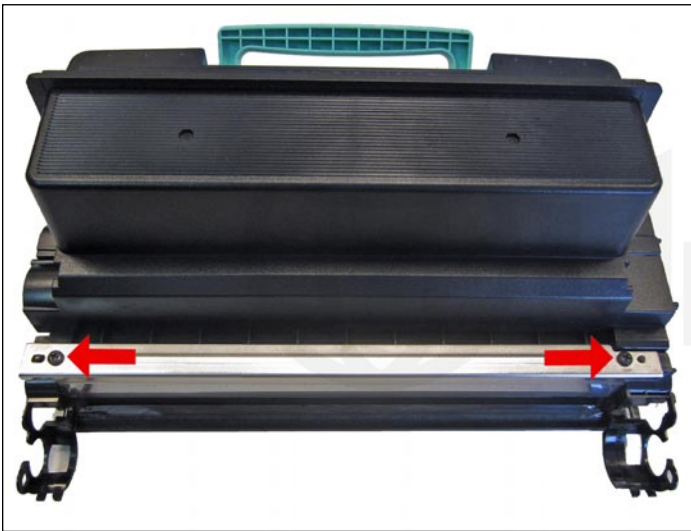

26. Install the doctor blade and two screws.

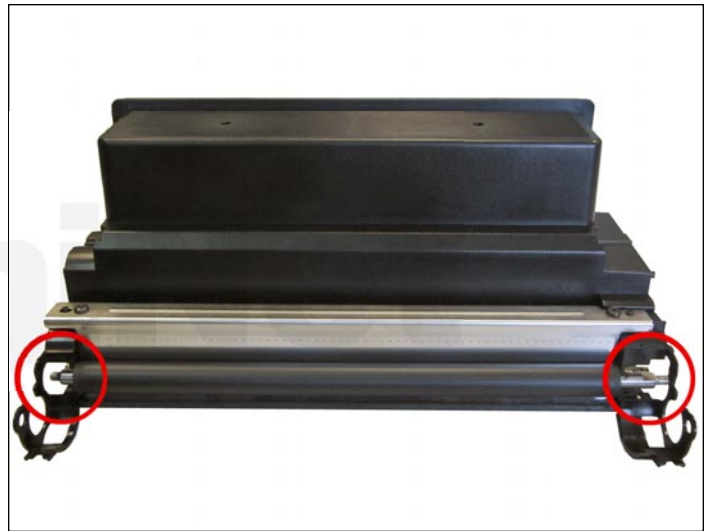

27. Clean the developer roller with a dedicated developer roller cleaner, and replace into the hopper. Place the long shaft side to the gear side of the cartridge. It should snap in place if installed correctly.



28. Clean and replace the conductive grease on the short shaft side of the roller.

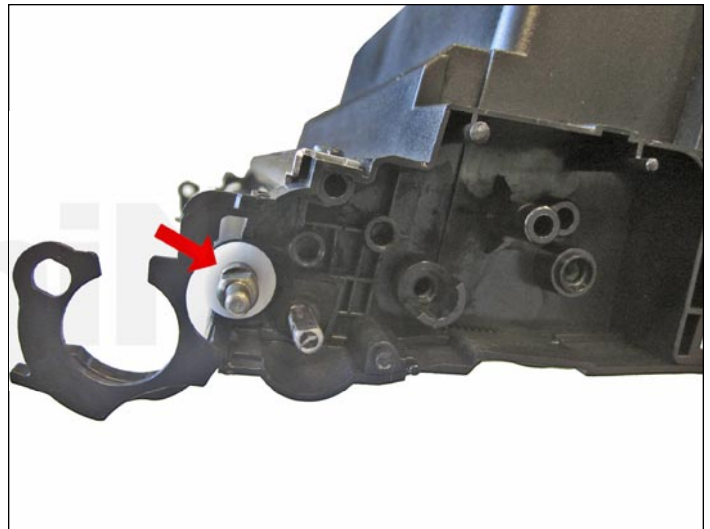

29. Replace the bushings on both side of the developer roller.

Fill the hopper with toner for use in Samsung ML-3750.
Replace the fill plug and check for leaks.

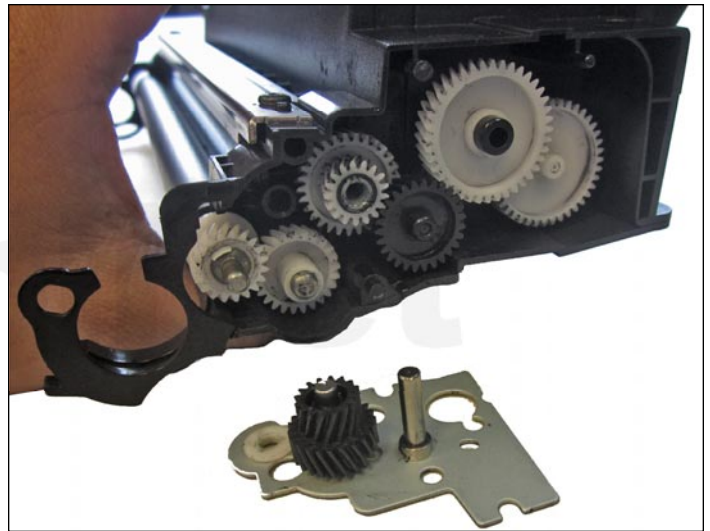
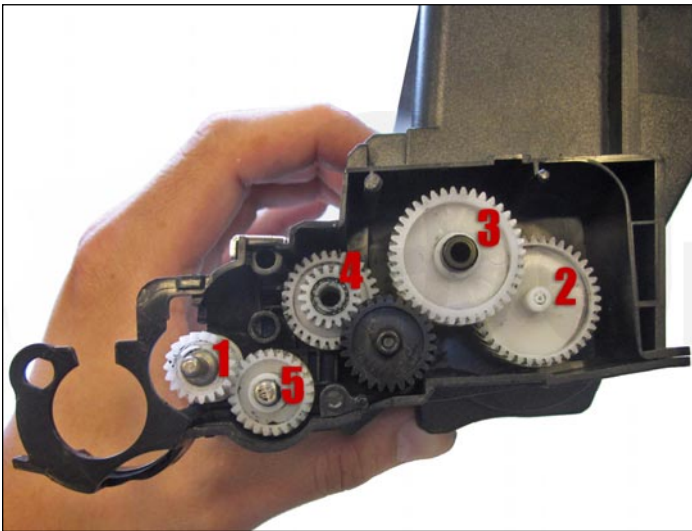

30. Install the gears in the order as shown.

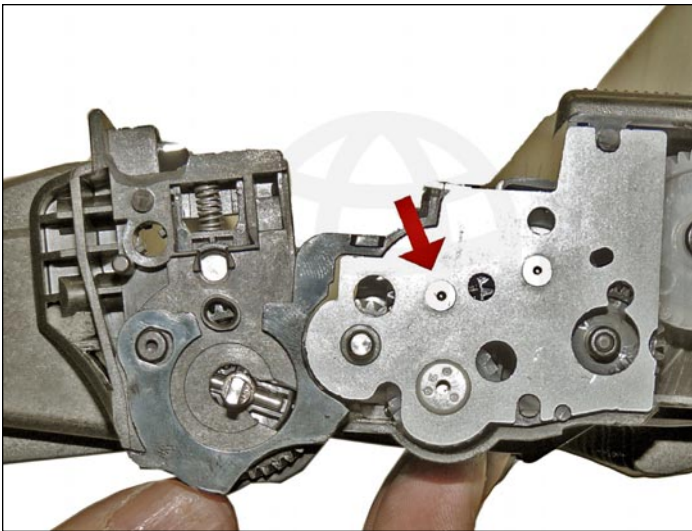

31. Install the gear axle plate.

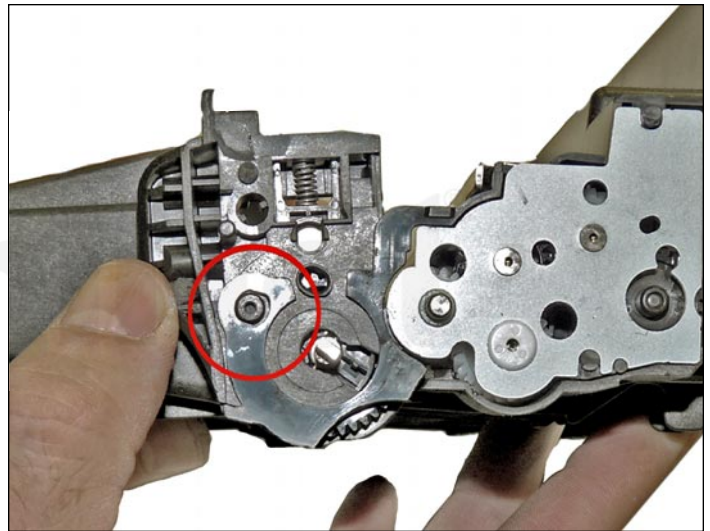
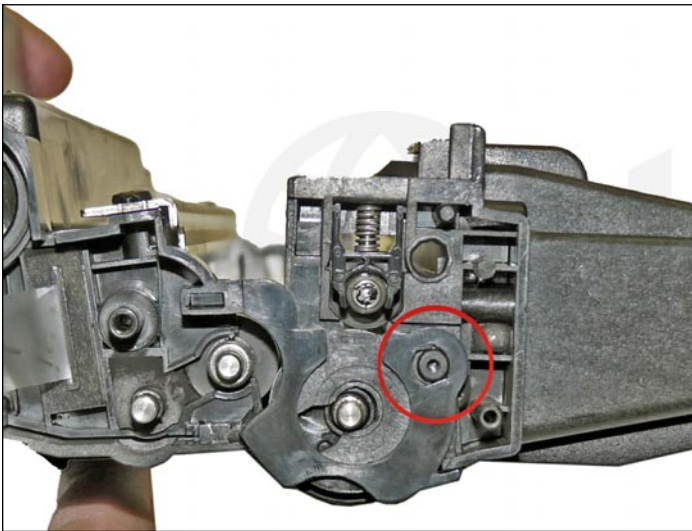

32. Fit both sides of the waste hopper tabs into the toner hopper.

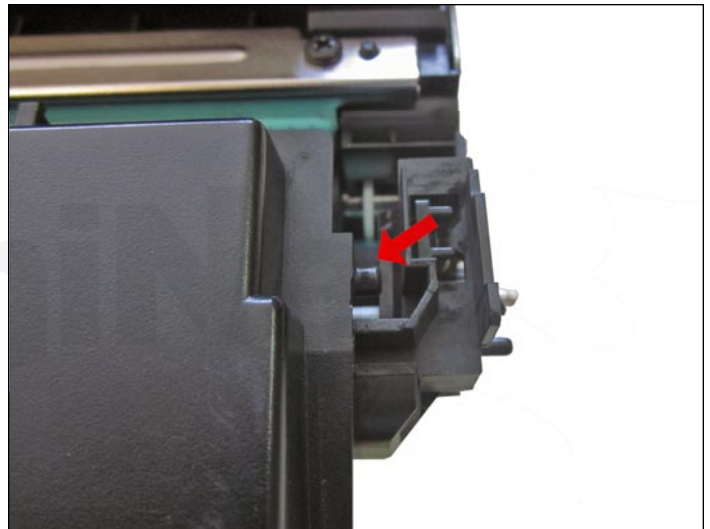
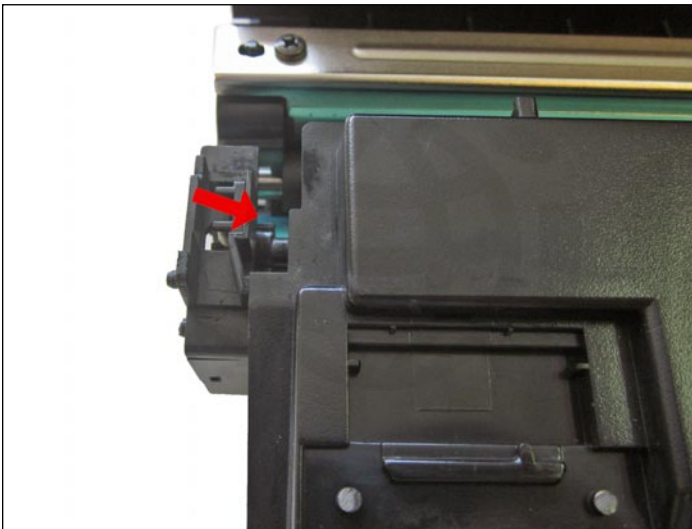
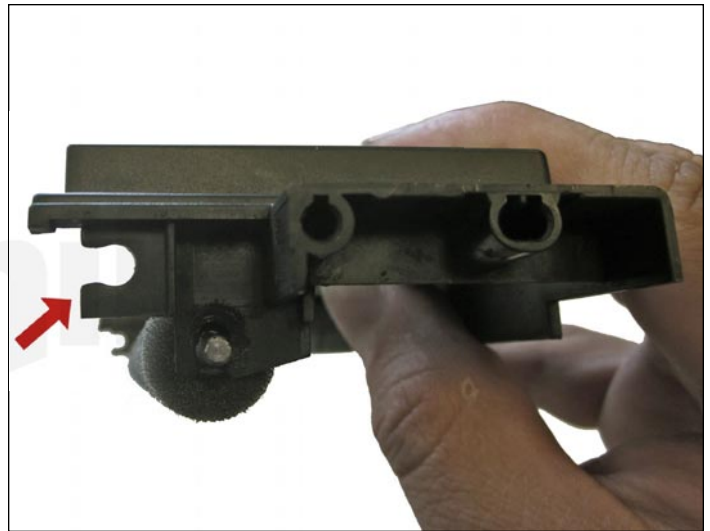
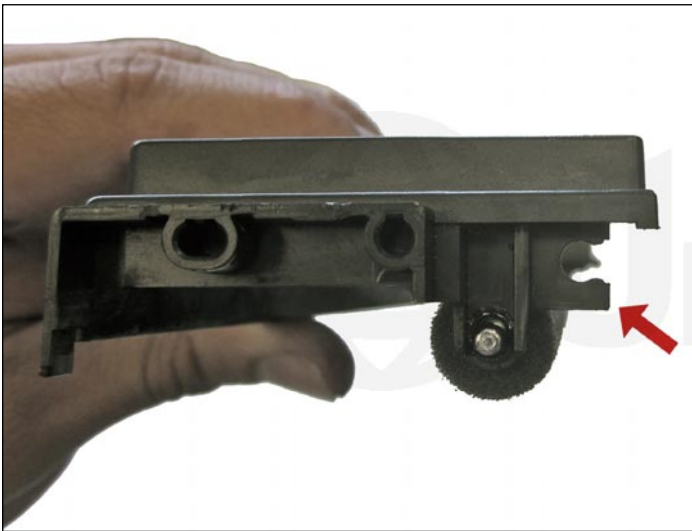

33. Slide the cleaned middle top cover/PCR cleaner assembly into place.

Make sure the "C" shaped areas snap into place.

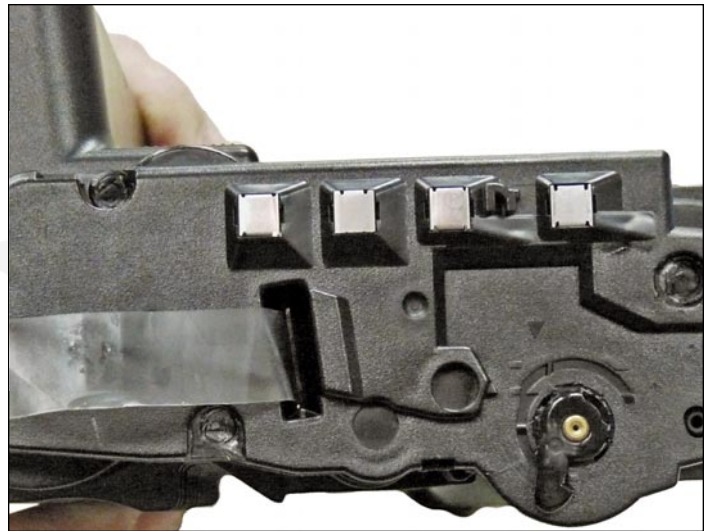
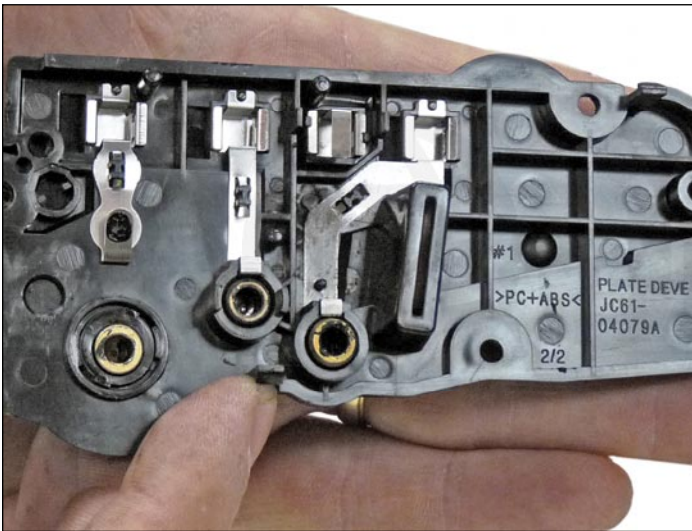

34. Clean the contacts on the left side end cap, and replace the conductive grease.

Snap the end cap into place.

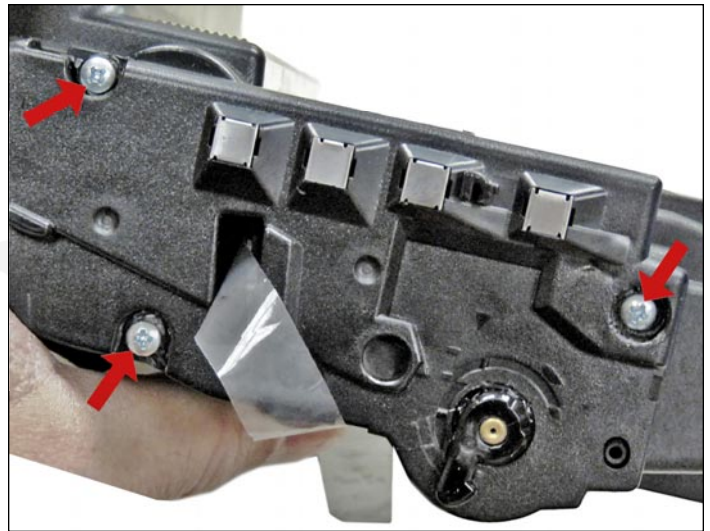

35. Drill three small holes that correspond to the screw size you're using.

Install the three screws into the end cap.

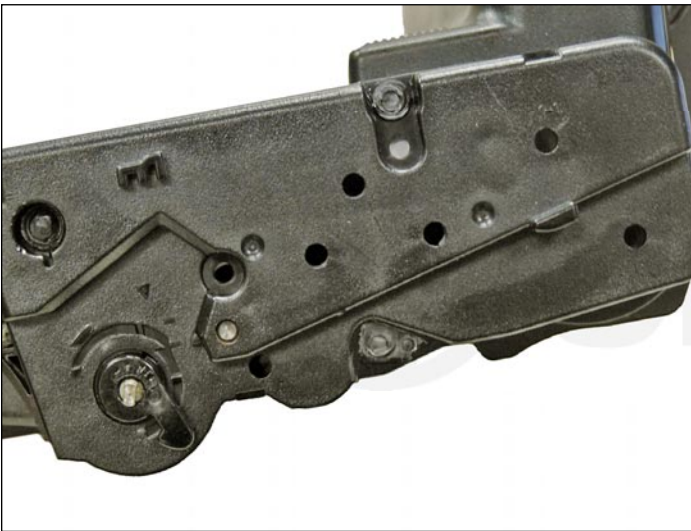

36. Clean the hubs on the gear side or right side end cap.

Snap the end cap into place.

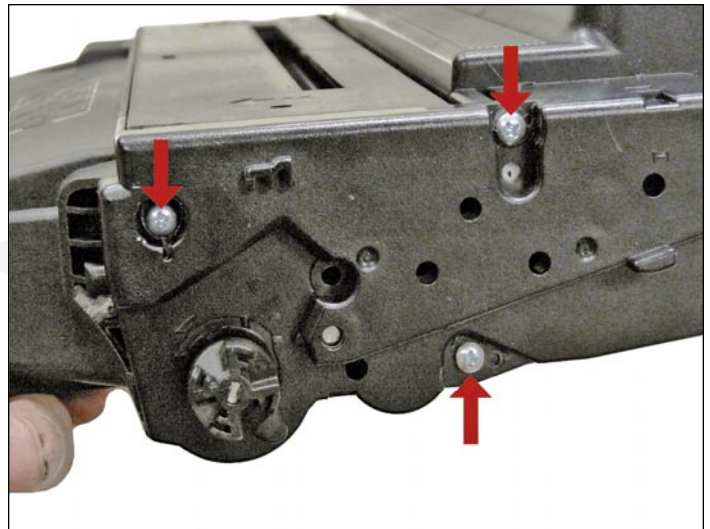
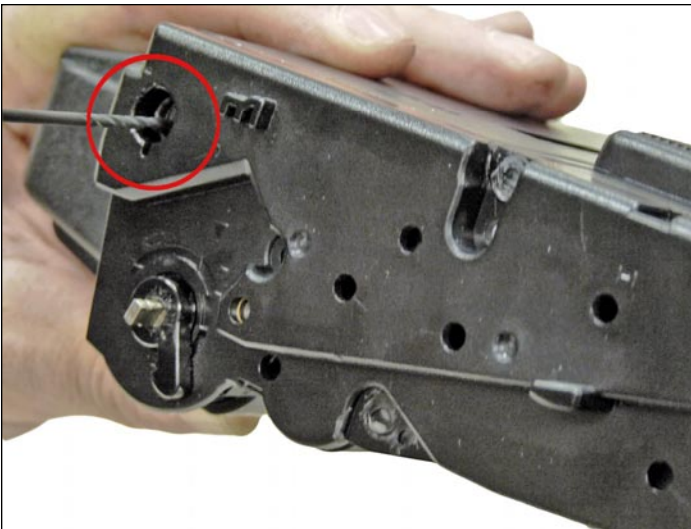

37. Drill three small holes that correspond to the screw size you are using.

Install the three screws into the end cap.

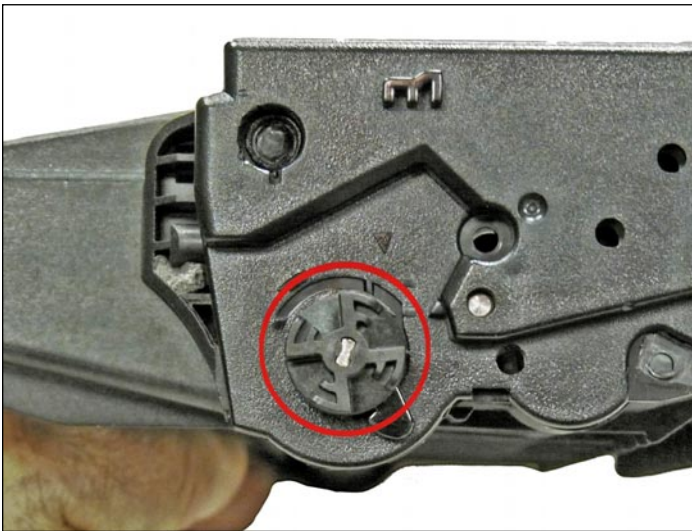

38. Install the drum drive gear.

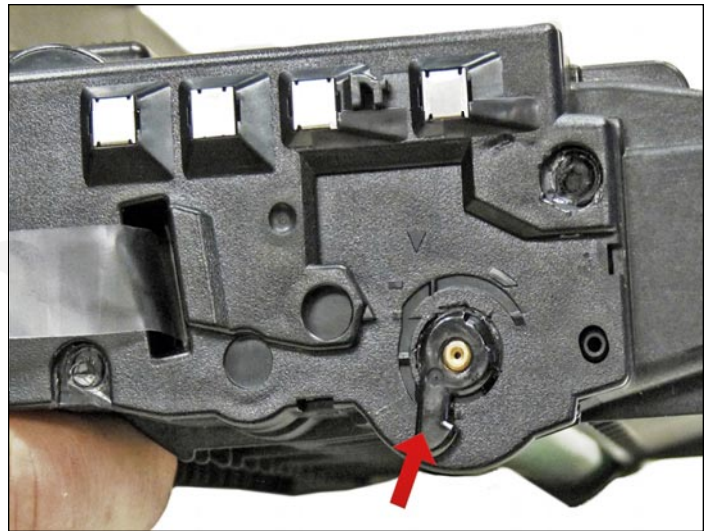

39. The drum separators are fixed to the end caps. They should be set as shown. These arms keep the drum and developer rollers separated until the cartridge is installed in the printer.

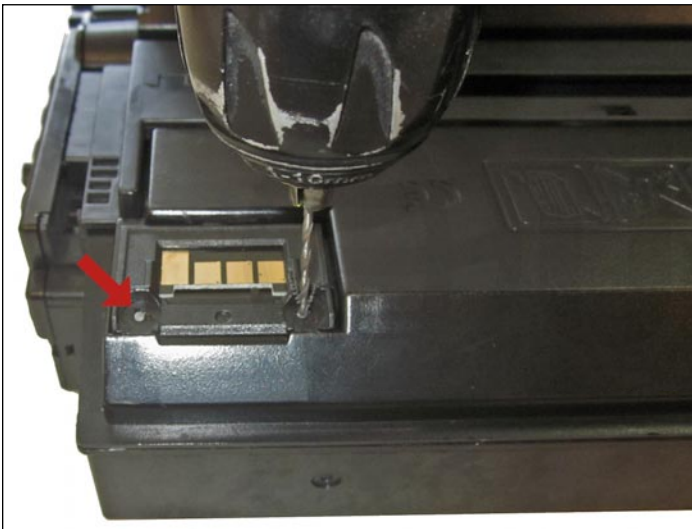

REPLACING THE CHIP

40. Drill holes that correspond to the screw size you are using.

Slice off the heads of the two plastic rivets with a blade knife.

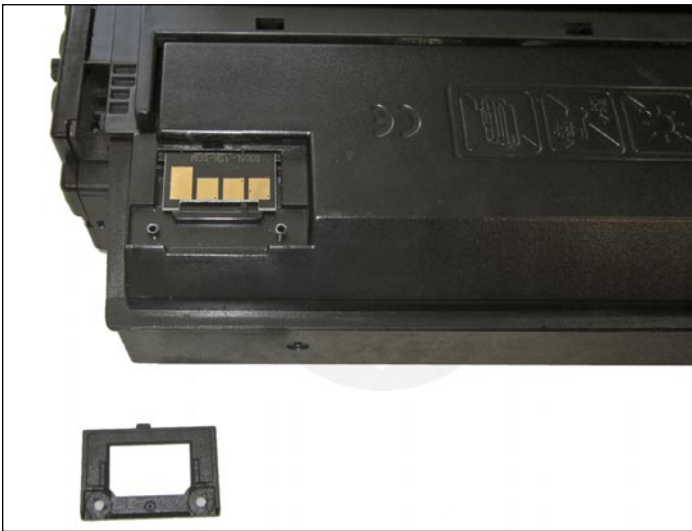

41. Remove the chip holder and replace the chip.



42. Install the chip holder, and install the two screws into the chip holder.

REPETITIVE DEFECT CHART

Upper heat roller:	77.5 mm
OPC drum:	75.6 mm
Lower pressure roller:	75.4 mm
Supply roller:	49.0 mm
Transfer roller:	47.0 mm
PCR:	37.5 mm
Developer roller:	35.0 mm

PRINTING TEST PAGES

Depending on the model machine you have, there are different control panel configurations:

1. To have test prints run on the laser printers, press the MENU button and scroll to the INFORMATION menu.
2. From there, you can select the MENU MAP, CONFIGURATION, SUPPLIES INFO, DEMO, FONTS pages, etc.