

# HP® PRO 400 M401 • MFP M425 CF-280A/X TONER CARTRIDGE REMANUFACTURING INSTRUCTIONS



HP® CF-280A/X TONER CARTRIDGE

# REMANUFACTURING THE HP LASERJET PRO 400 M401/MFP M425 (CF-280A/X) TONER CARTRIDGE

By Mike Josiah and the Technical Staff at UniNet

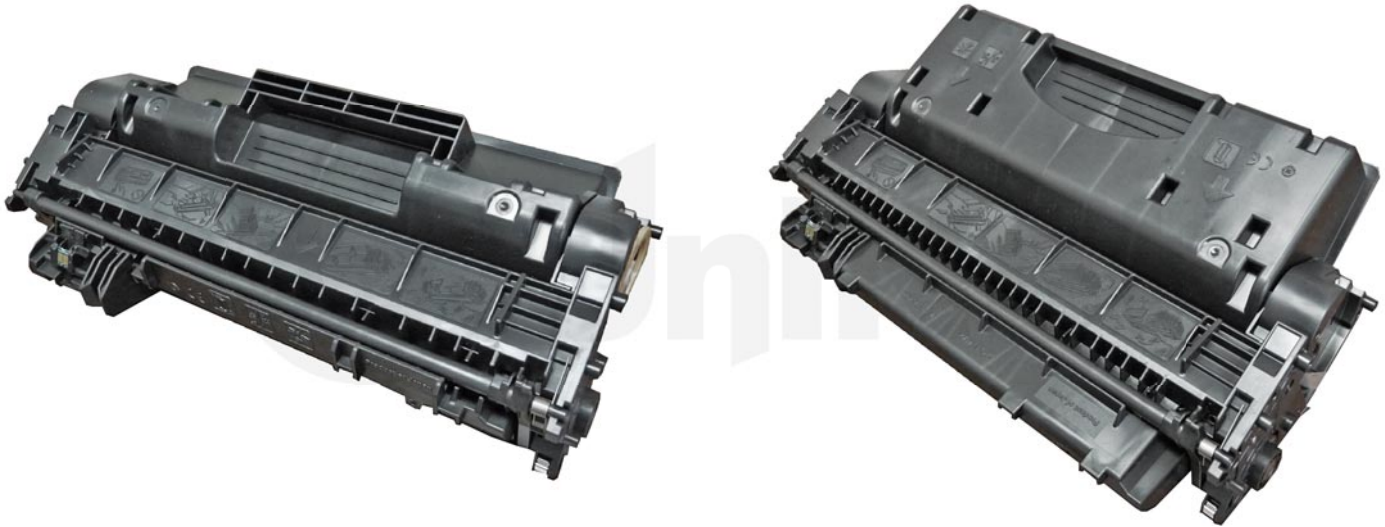

First introduced in June 2012, the LaserJet Pro 400 M401 series of laser printers is based on 35 ppm, 1200 dpi Canon engine that comes standard with 256Mb memory. Two different cartridges are available for this series, the CF280A rated at 2,700 pages, and the CF280X rated for 6,900 pages.

These machines are different from the LaserJet 300/400 series. The engines and cartridges are totally different. This will most likely be a bit confusing for customers, as when talking about the machines I've noticed people leaving off the "Pro" part.



The cartridges are similar in design to the P2035 cartridges, but are not interchangeable. The drum drive gear is also basically the same as the P2035. It is a floating type that uses a ball and socket configuration.

By the time you are reading this, conversion kits to convert CE505A/X cartridges to CF-280A/X will be available.

These cartridges use a pin system to hold the two halves of the cartridge together. You will need to cut two small holes cut in the top to get access to the pins. The pin access hole location on these cartridges is almost identical and the same methods you use for the P2035 should work here.

### **PRINTERS RELEASED IN THIS SERIES SO FAR**

**Pro 400 M401n**

**Pro 400 M401dn**

**Pro 400 M401dw**

**Pro 400 MFP M425dn**

**Pro 400 MFP M425dw**

Cartridge troubleshooting some simple printer troubleshooting will be covered at the end of this article.

### **SUPPLIES REQUIRED**

1. Low yield replacement toner for use in the HP M401 CF280A cartridge (120g / 2,700 pages)
2. High yield toner for use in the HP M401 CF280X cartridge (290g / 6,900 pages)
3. Replacement Chip
4. New drum (optional)
5. Wiper blade (optional)
6. Doctor blade (optional)
7. Magnetic roller (optional)
8. Sealing strip (optional)
9. Cotton swabs
10. Isopropyl alcohol
11. Drum padding powder

### **TOOLS REQUIRED**

1. Jeweler's screwdriver
2. Phillips head screwdriver
3. Small common screwdriver
4. X-Acto knife with square chisel type blade (#17)
5. Flush cutting wire cutters
6. Dremel-type tool with side grinding bit
7. 3/32" drill bit
8. Small (#4 1/4") long self-tapping screws

### **TOOLS REQUIRED TO REMOVE/INSTALL OLD OEM GEARS**

1. Metal 3/16" rod about 18" long (from local hardware store)
2. Needle-nose pliers
3. Super-glue or equivalent
4. Rubber mallet
5. Voltage meter

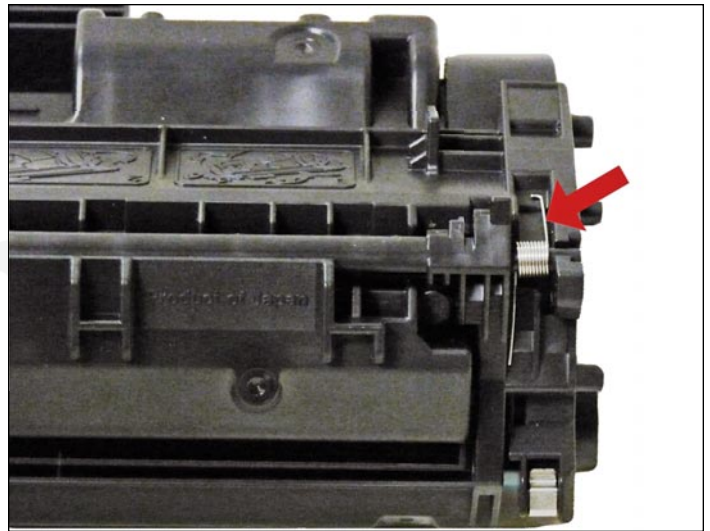
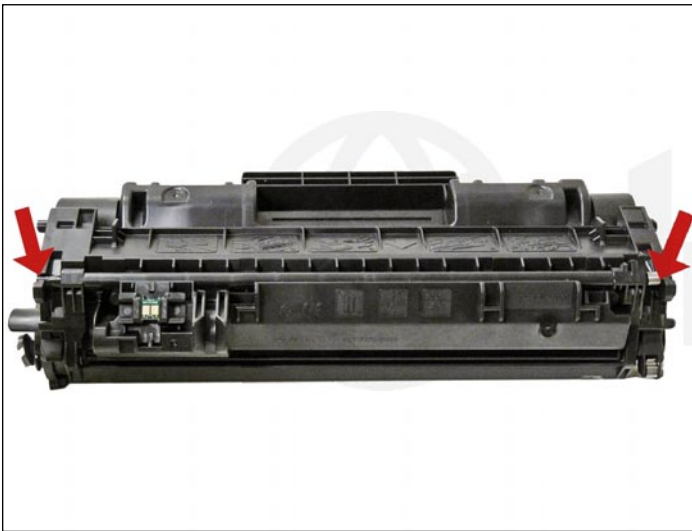

1. The pins need to be removed to open the cartridge. The best way to remove them without damaging the cartridge is to cut two small holes. Remove the drum cover by prying up on each end. Note the spring position so that it can be replaced later.

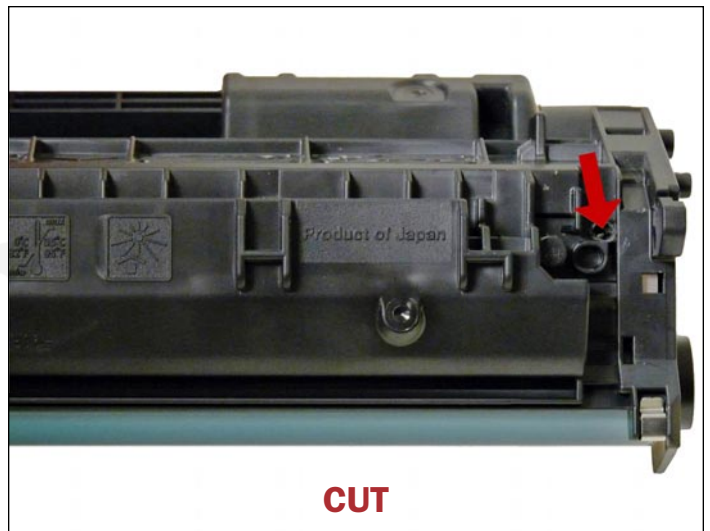
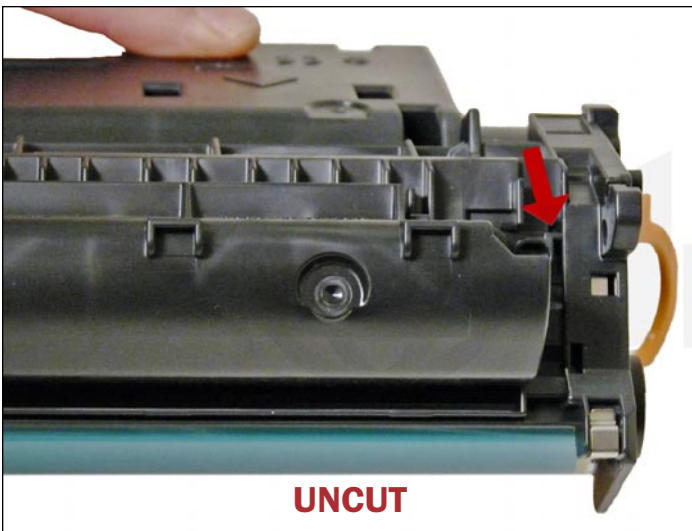
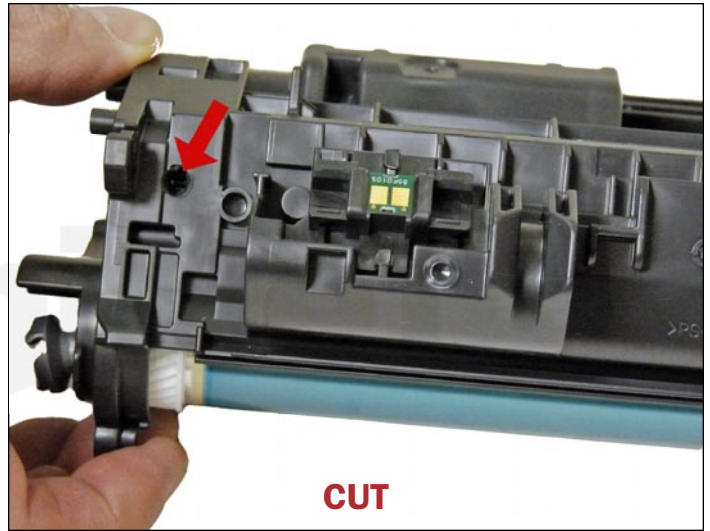
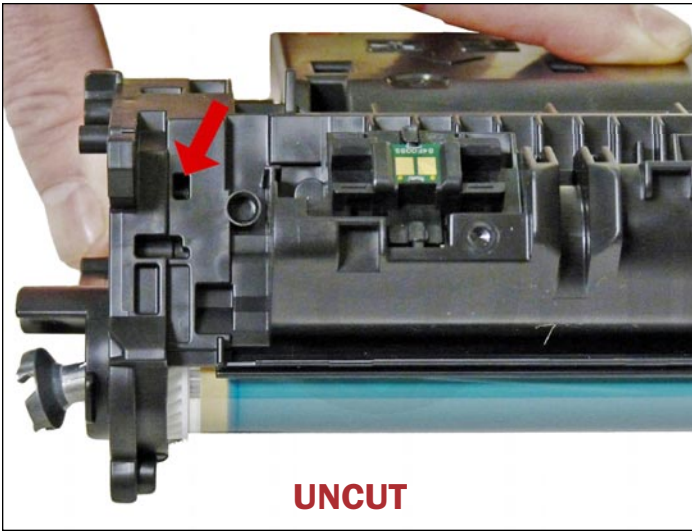

2. Drill a shallow hole on each side of the cartridge as indicated.

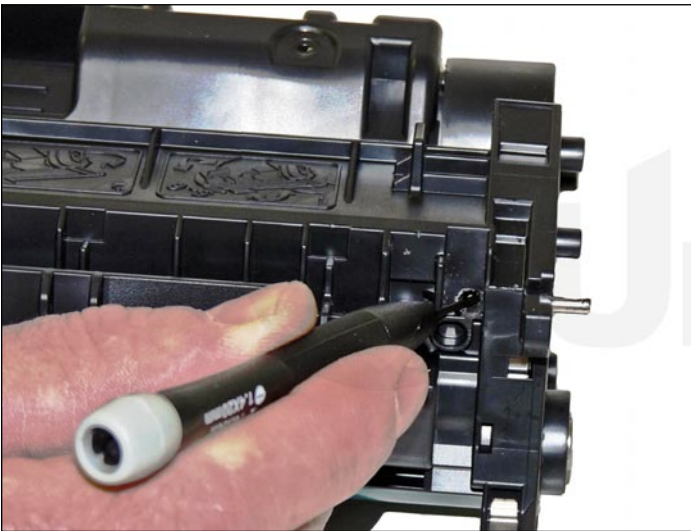

3. Push the pins out with a jeweler's screwdriver. With the hole in this location, by just pushing the screwdriver in, the pins will be pushed out. Remove the pins.

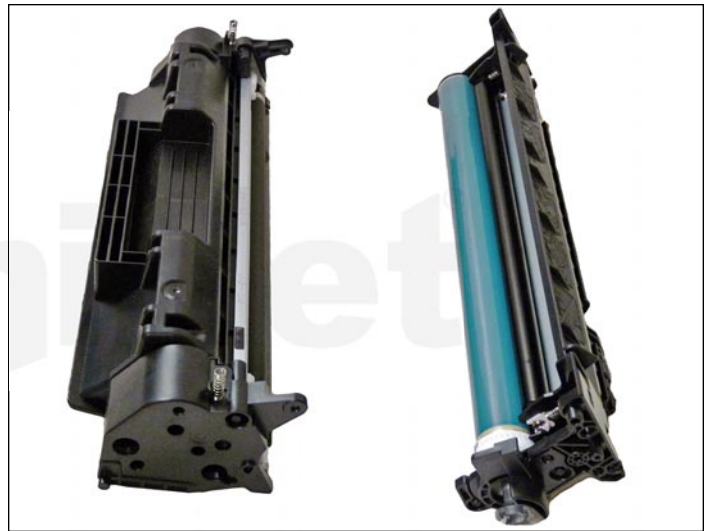

4. Separate the two halves.



5. With a flathead screwdriver, press the drum axle pin out from the inside of the cartridge wall as shown. There is a small shoulder visible that the screwdriver should be pressed against. Make sure not to bend or damage the plastic wall and the plastic is thin and easily damaged. Remove the Axle pin from the outside with flush cutting wire cutters.



The drum hub on the opposite side is welded. The weld can be broken or drilled out, but there is a good chance that the hub will either warp if pried off, or will be hard to align if drilled out.

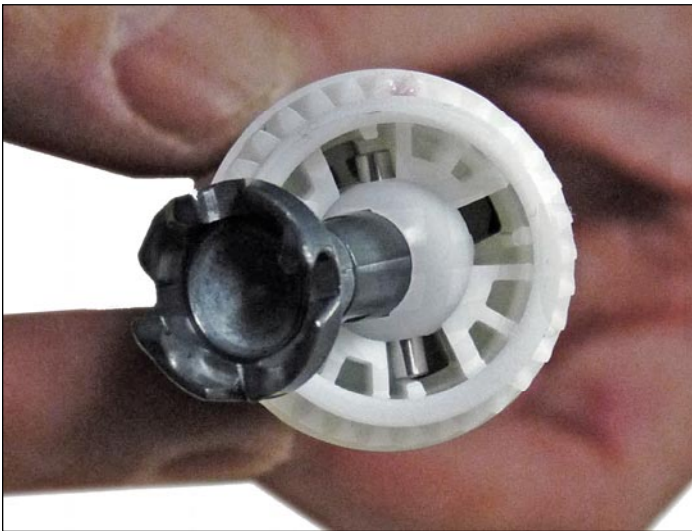

6. Remove the drum.

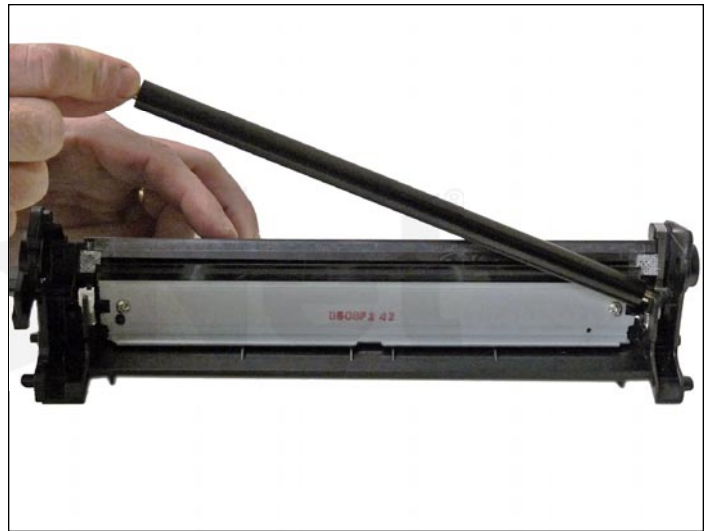

7. Remove the PCR and clean with your standard PCR cleaner.



8. Remove the two screws and the wiper blade.

9. Clean out the waste toner.



10. Coat the wiper blade with your preferred lubricant.

Install the blade and two screws.

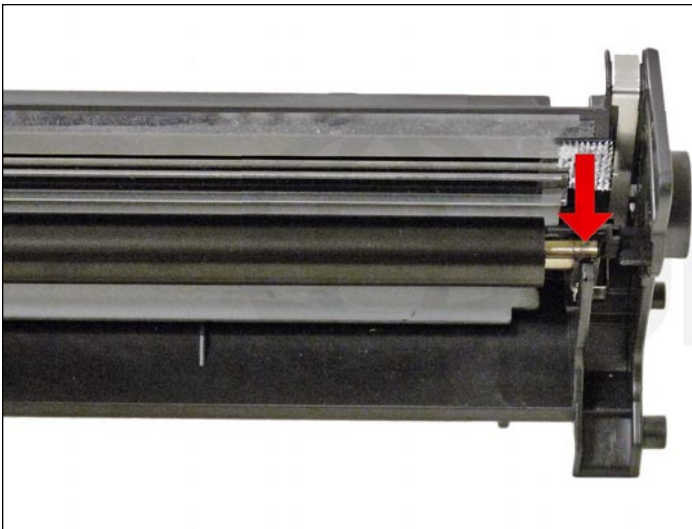

11. Re-install the cleaned PCR. Note that a new OEM PCR has a small amount of conductive grease on the black (contact) side.



12. Re-install the OEM OPC drum and metal axle pin. The metal axle pin should have a small amount of conductive grease on the tip. Remove the old grease and replace before inserting the pin. Make sure the axle pin is fully inserted.



If you are replacing the OEM drum, follow this procedure to remove the gears and install them on the new drum...

13. Locate the swivel hub on the OPC drive gear shown.



14. Remove the swivel hub on the drive gear by pulling it out using pliers.



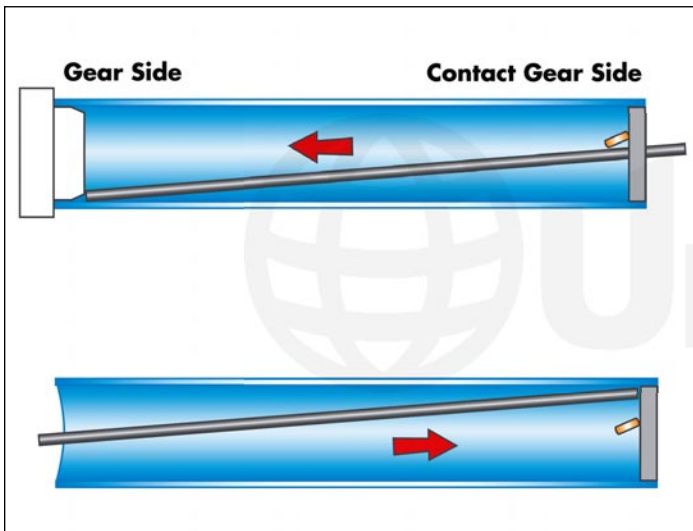

15. Slide a 3/16" metal rod about 18" long, along the drum wall, until it meets the sidewall of the gear. Lightly tap the rod a few times with a hammer, rotate the drum and do the same until it comes loose. Normally it will take three to four taps for the gear to come loose. Do the same for the contact side taking care not to place the rod anywhere near the copper contacts that bite into the drum.



16. Straighten out the contacts on the contact gear.

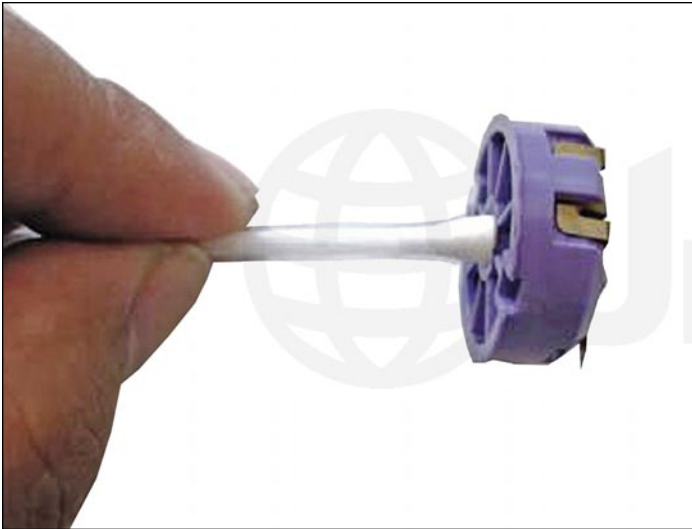

17. Clean the contacts using a cotton swab and alcohol.

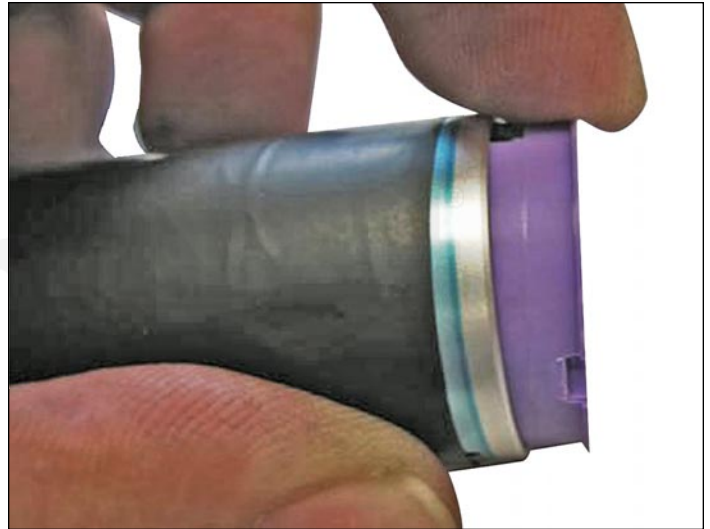

18. Apply a few drops of super-glue around the inside of the drum, about 1/8" in from the edge. Make sure you leave space with no glue present for the contacts to touch the metal drum wall. These contacts must be metal-to-metal with no glue in between them. If any glue is in between the contacts and drum wall, there will be drum ground issues (solid black pages). Install the contact gear.



19. On the opposite side, place a few drops of medium or thick super-glue on the inside wall of the drum about 1/8" in from the edge. This will prevent the glue from overflowing into the drum coating when the drive gear is installed.



20. Install the drive gear. Place the drum onto a flat surface and gently tap the gear with a rubber mallet until the gear sits flush.

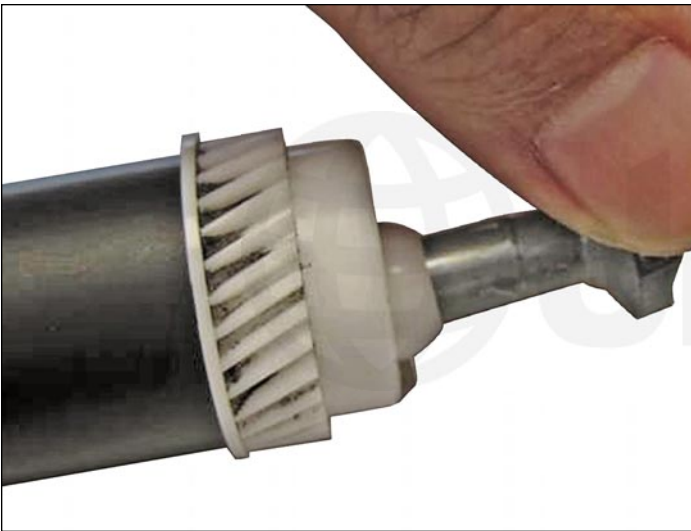

21. Install the swivel hub into the drive gear.



22. Check the drum ground with an ohmmeter. Place the probes into the drum contact and drum (very edge on the drum where there is no coating), and check for continuity. Be very careful to keep the one lead on the edge of the drum. The top metal part has a clear protective coating on it and is easily scratched. Do not press in hard or the lead will slide across the drum ruining it. Allow the glue to dry for about a couple of minutes and the drum should be ready to use.

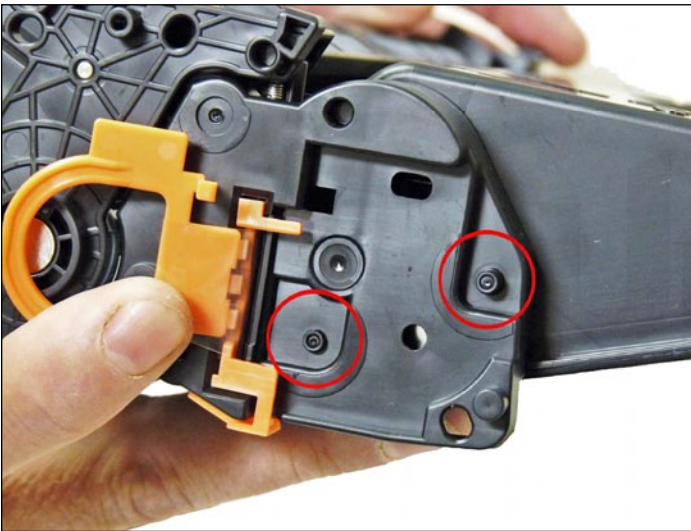

23. On the supply chamber, slice the two tabs off each location as shown on the left (seal) end cap. Use a square-blade X-Acto knife to slice off the tabs.



24. NOTE: Both the end caps are plastic welded in place. The only way to open them up is to cut the welds and carefully drill them out. We have found the left (non-gear) side is the best side to do this on. Using the 3/32" drill bit, drill out each of the two welds. Be careful to keep the drill straight as you drill in. Use a slow speed and only drill in no more than 1/4".

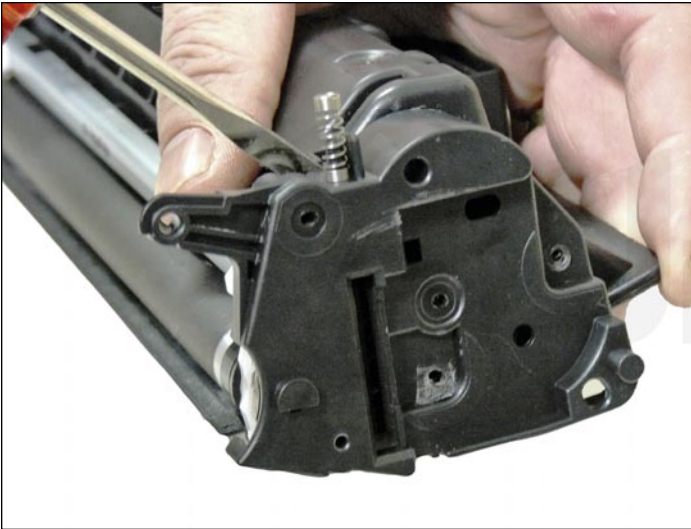

25. With a flat head screwdriver work the edge of the blade around the edge of the end cap and gently pry up the end cap. You will hear the remaining parts of the welds break free. The top weld will also break off now. Take your time with this.



26. Remove the magnetic roller assembly.

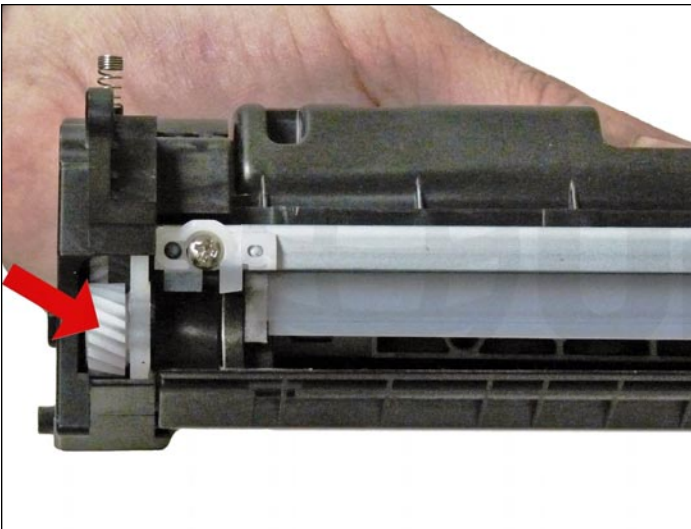

27. Remove the magnetic roller drive gear. The end cap will keep the bushing in place.

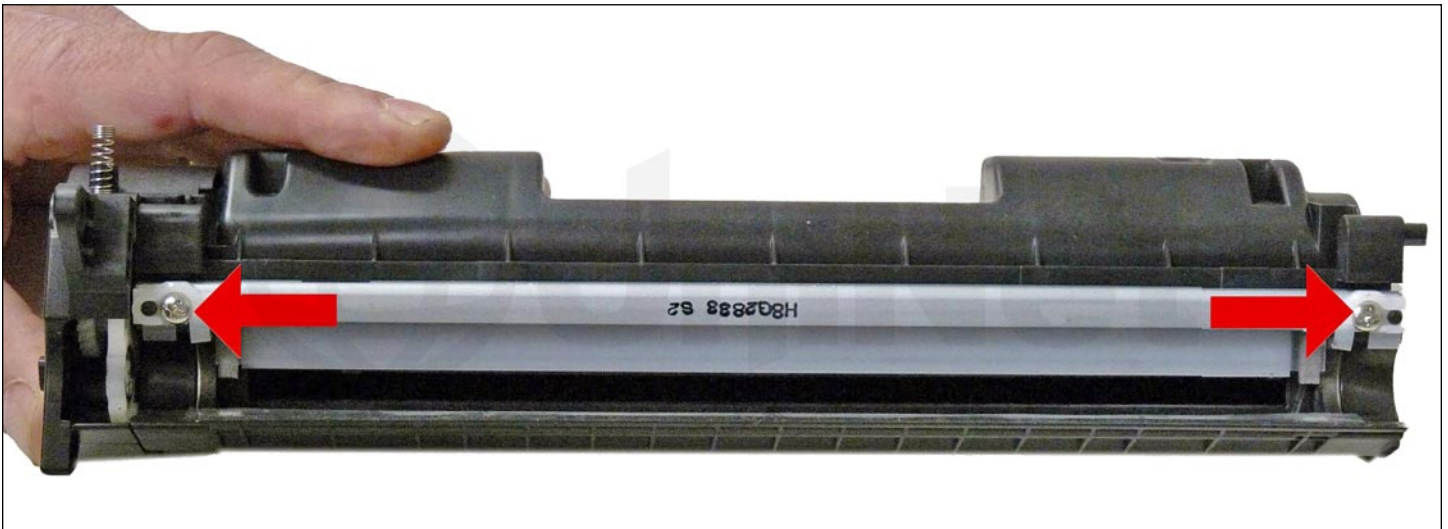

28. Remove the developer roller, blade, and two screws.

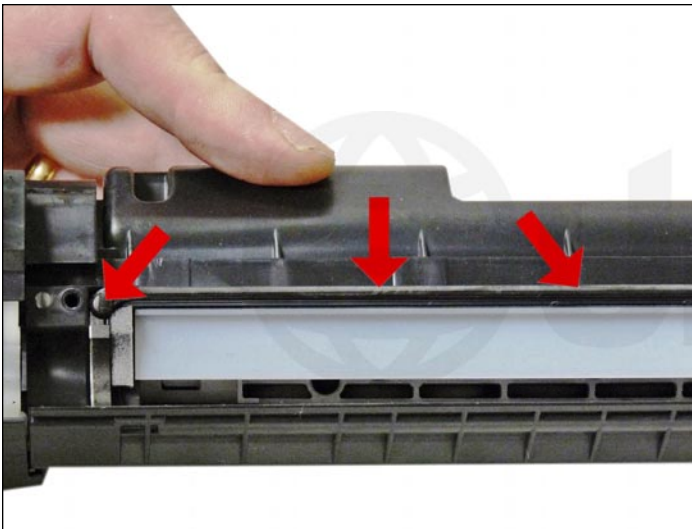

29. Clean out any remaining toner from the hopper. Note the doctor blade seal. It is a sticky substance that can be cleaned with alcohol if toner gets on it.



30. Fill through the magnetic roller opening with 120g of toner for use in P2035 "A" cartridge, or 290g for the "X". There is no fill plug in these cartridges.



31. If you are going to seal the cartridge, there is a white plastic shelf that needs to be removed. The shelf is held on with double-sided tape. It can be gently pried off with a small screwdriver.

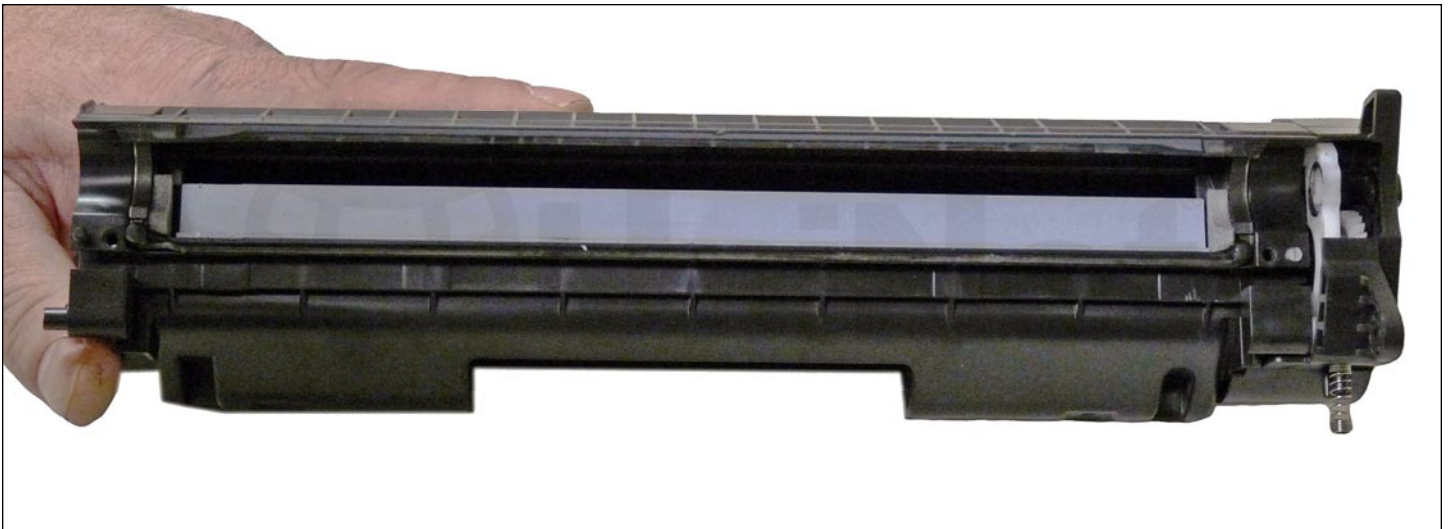

32. Re-install the white plastic shelf.

If the adhesive is not working, replace it with a good double-sided tape.

This shelf helps with the flow of toner in the hopper.



33. Re-install the doctor blade and two screws.

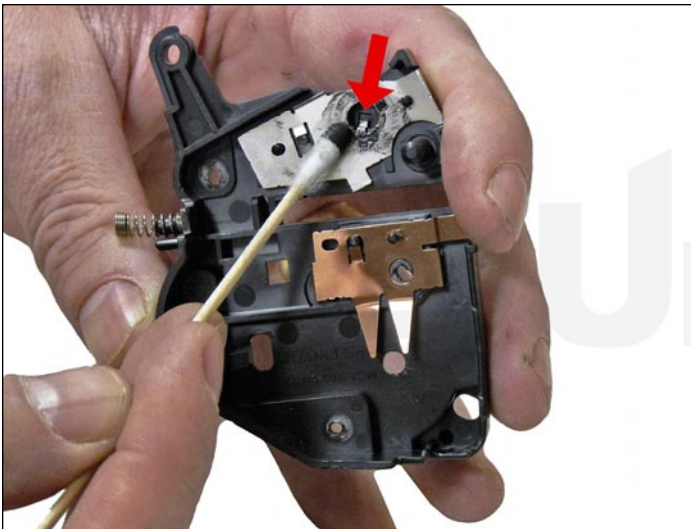

34. Clean the old grease off the contact plate, and replace with new conductive grease.

UniNet®

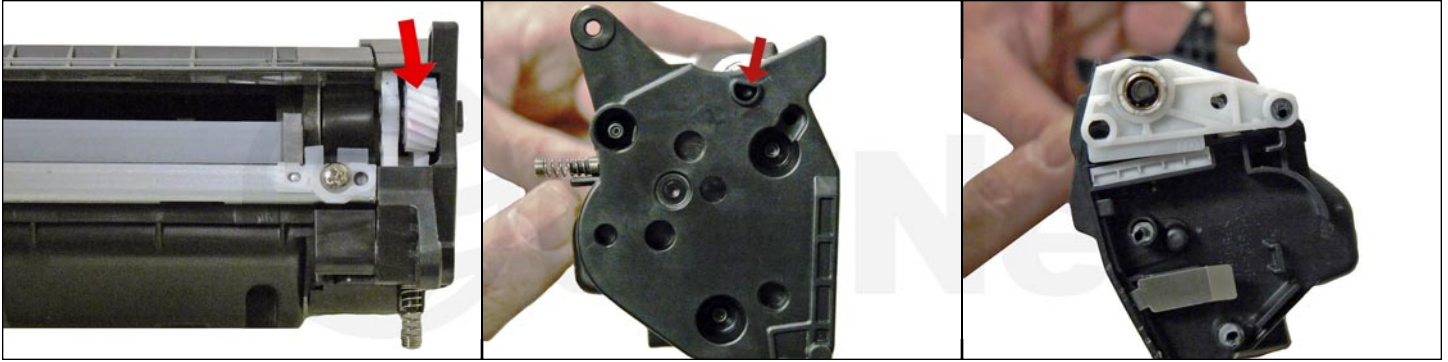

35. Re-assemble the toner hopper section. Place the magnetic roller drive-gear in place, and install the magnetic roller assembly. Turn the roller until the keyed end fits into the drive gear properly. Install the end cap, align the keyed magnet into the keyed slot on the gear side first, this will help in aligning the opposite end cap.

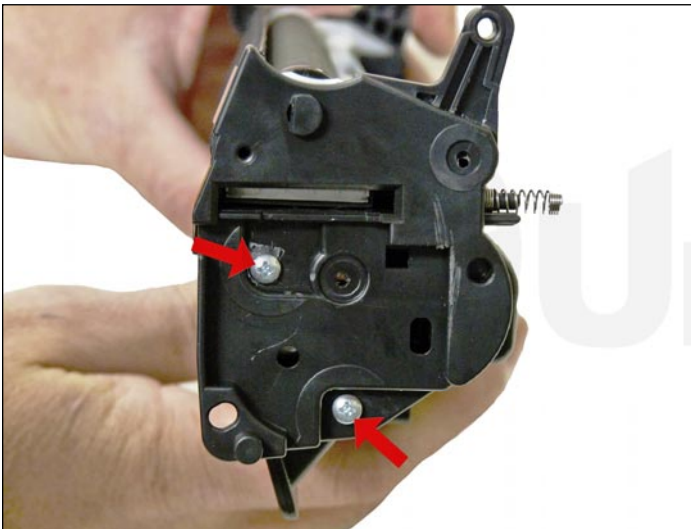

36. Install two small screws into the holes previously drilled out. Leave the top third hole alone (this weld was broken when the end cap was removed). A screw here will interfere with installing the cartridge in the printer. In our tests, the two screws will hold the end cap on with no problems.



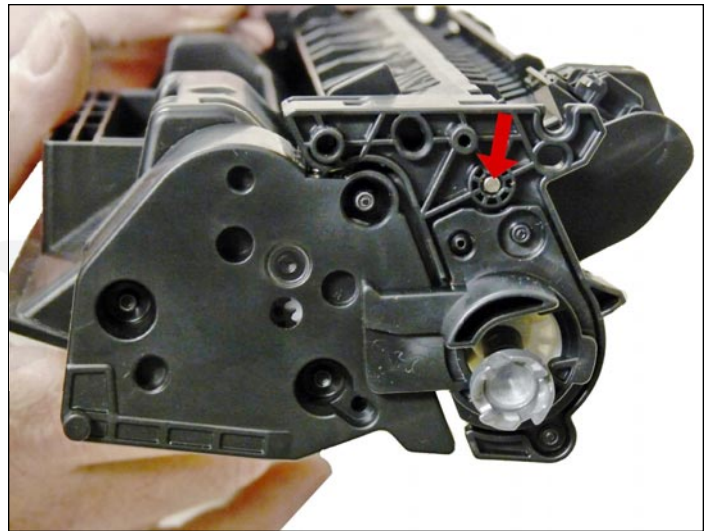
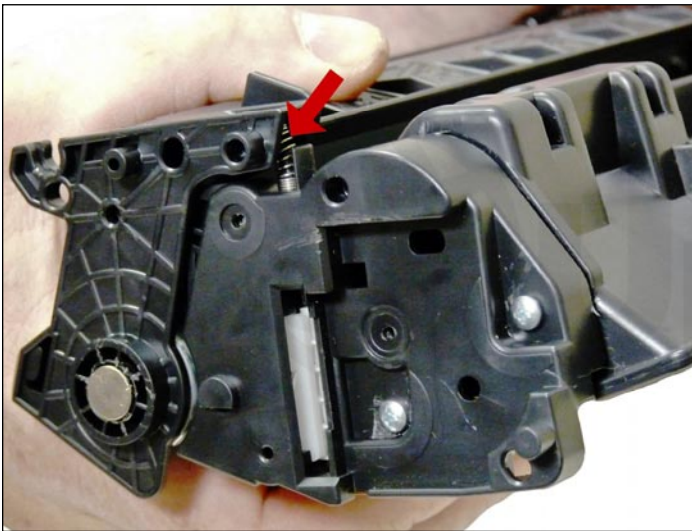

37. Place the two halves together, make sure that the two springs are aligned, and insert the two pins.

Make sure that the pins are slightly pushed in so that they do not interfere with installing the cartridge in the printer.



38. Install the drum cover.

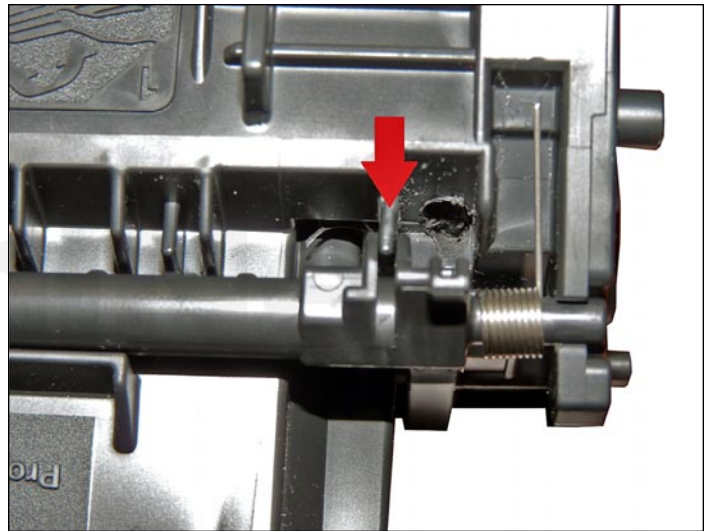
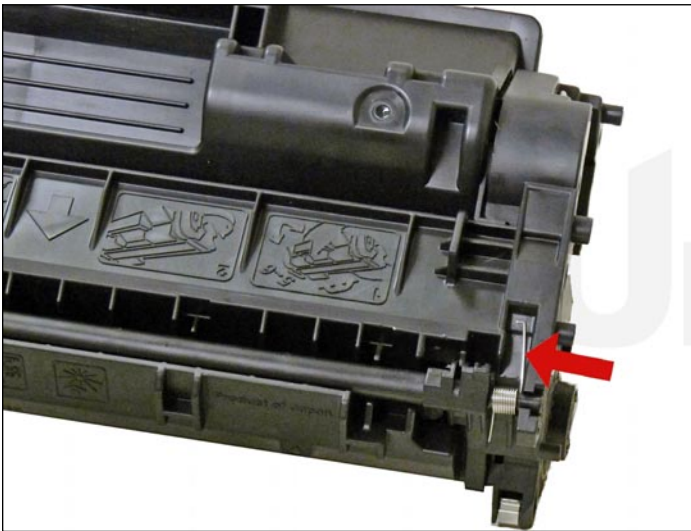

Make sure the spring is situated correctly, and the slot on the cover fits into the tab on the cartridge.

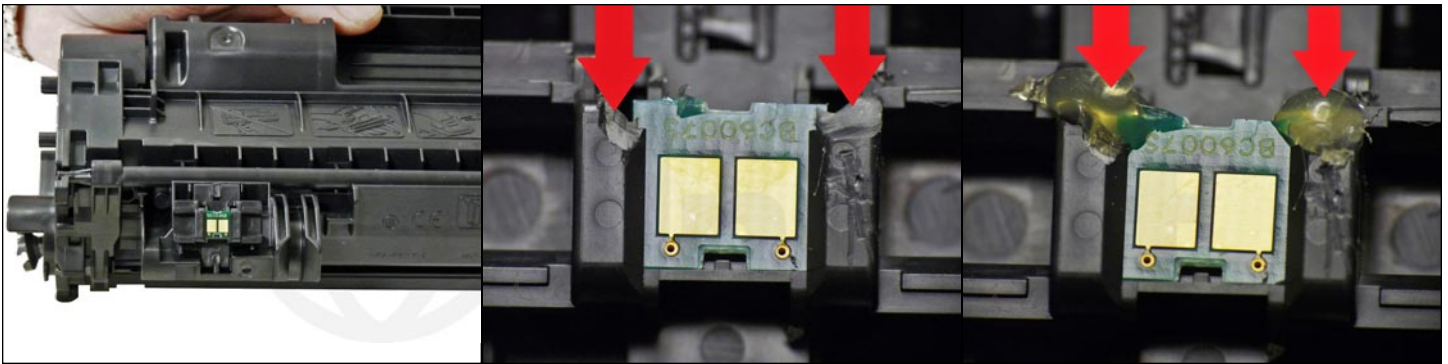

39. Replace the chip by slicing off the top two corners of melted plastic and sliding the chip out. After replacing the chip if it seems a little loose in the slot, place a dab of hot glue on each of the corners that you sliced off. The hot glue is easily removed when recycling the cartridge again, but will firmly hold the chip in place.

**REPETITIVE DEFECT CHART**

|                             |              |
|-----------------------------|--------------|
| <b>OPC drum:</b>            | <b>75 mm</b> |
| <b>Lower fuser roller:</b>  | <b>63 mm</b> |
| <b>Upper fuser film:</b>    | <b>57 mm</b> |
| <b>Registration roller:</b> | <b>43 mm</b> |
| <b>Magnetic roller:</b>     | <b>42 mm</b> |
| <b>Transfer roller:</b>     | <b>39 mm</b> |
| <b>PCR:</b>                 | <b>38 mm</b> |